

# SIRUBA®

銀箭牌工業用縫紉機  
INDUSTRIAL SEWING MACHINE











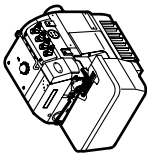







# 700FS

## 零件圖 PARTS LIST

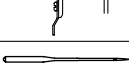

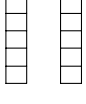
CE

 高林股份有限公司  
KAULIN MFG. CO., LTD.

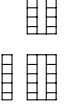
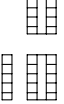
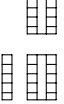
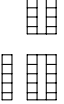
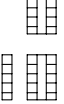
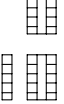
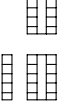
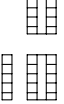
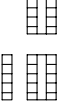
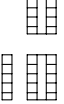
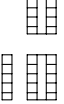
	GAUGE NG SM																		
737FS-505F1-04	4	E304	D103	D102	H104	1.6	P152D-3	—	LP26	KG131	KF25	KJ09B	KJ10	#9	5.5		KL62	KL11	8000
737FS-505F1-04/ESS	4	E304	D103	D102	H104	1.6	P152D-3	—	LP26	KG131	KF25	KJ09B	KJ10	#9	5.5		KL62	KL11	8000
737FS-505F1-04/VT	4	E304	D103	D102	H104	1.6	P152D-3	—	LP26	KG131	KF25	KJ09B	KJ10	#9	5.5		KL62	KL11	8000
737FS-505F1-04/ESS/VT	4	E304	D103	D102	H104	1.6	P152D-3	—	LP26	KG131	KF25	KJ09B	KJ10	#9	5.5		KL62	KL11	8000
737FS-504M2-04	4	E324	D117	D116	H118	1.6	P987-3	KS62	LP26	KG131	KF26	KJ11B	KJ13	#11	6.5		KL60	KL11	6300
737FS-504M2-04/VT	4	E324	D117	D116	H118	1.6	P987-3	KS62	LP26	KG131	KF26	KJ11B	KJ13	#11	6.5		KL60	KL11	6300
737FS-504M2-04/LFC-ZS	4	E324	D117	D116	H118	1.6	P111-3	KS62	LP26	KG131	KF26	KJ11B	KJ13	#11	6.5		KL60	KL11	6300
747FS-514M2-24	2	E434	D117	D116	H118	1.6	P987-4	KS62	LP26	KG142	KF26	KJ11B	KJ13	#11	5.5		KL60	KL11	6000
747FS-514M2-24/VT	2	E434	D117	D116	H118	1.6	P987-4	KS62	LP26	KG142	KF26	KJ11B	KJ13	#11	5.5		KL60	KL11	6000
747FS-514M2-24/CT	2	E424	D103	D116	H118	1.6	P987-4	KS62	LP26	KG142	KF26	KJ11B	KJ13	#11	5.5		KL60	KL11	6000
747FS-514M4-24	2	E424	D103	D116	H118	1.6	P987-4	KS62	LP26	KG142	KF25	KJ69	KJ10	#11	6.5		KL62	KL11	7500

PARTS LIST FOR KA GROUP

PARTS LIST FOR KB GROUP

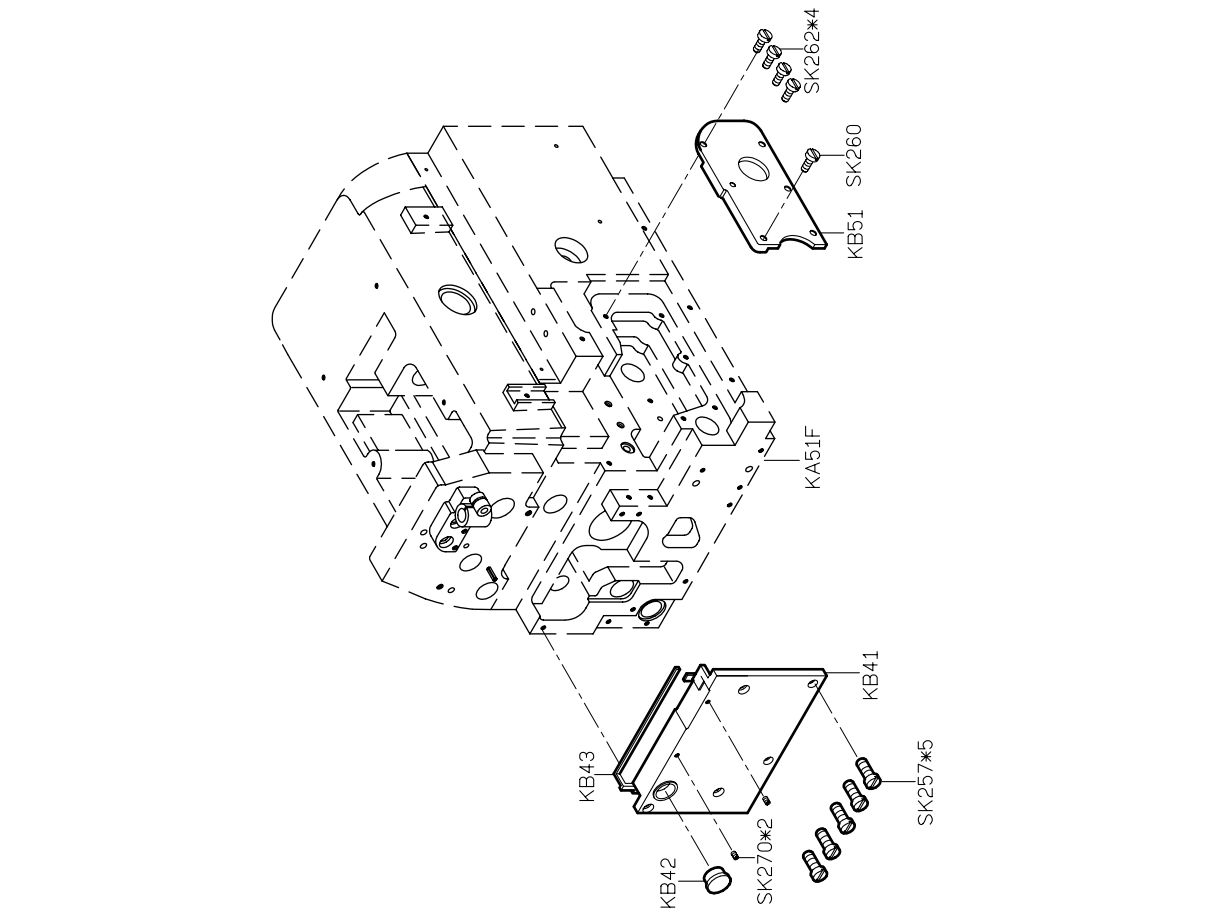
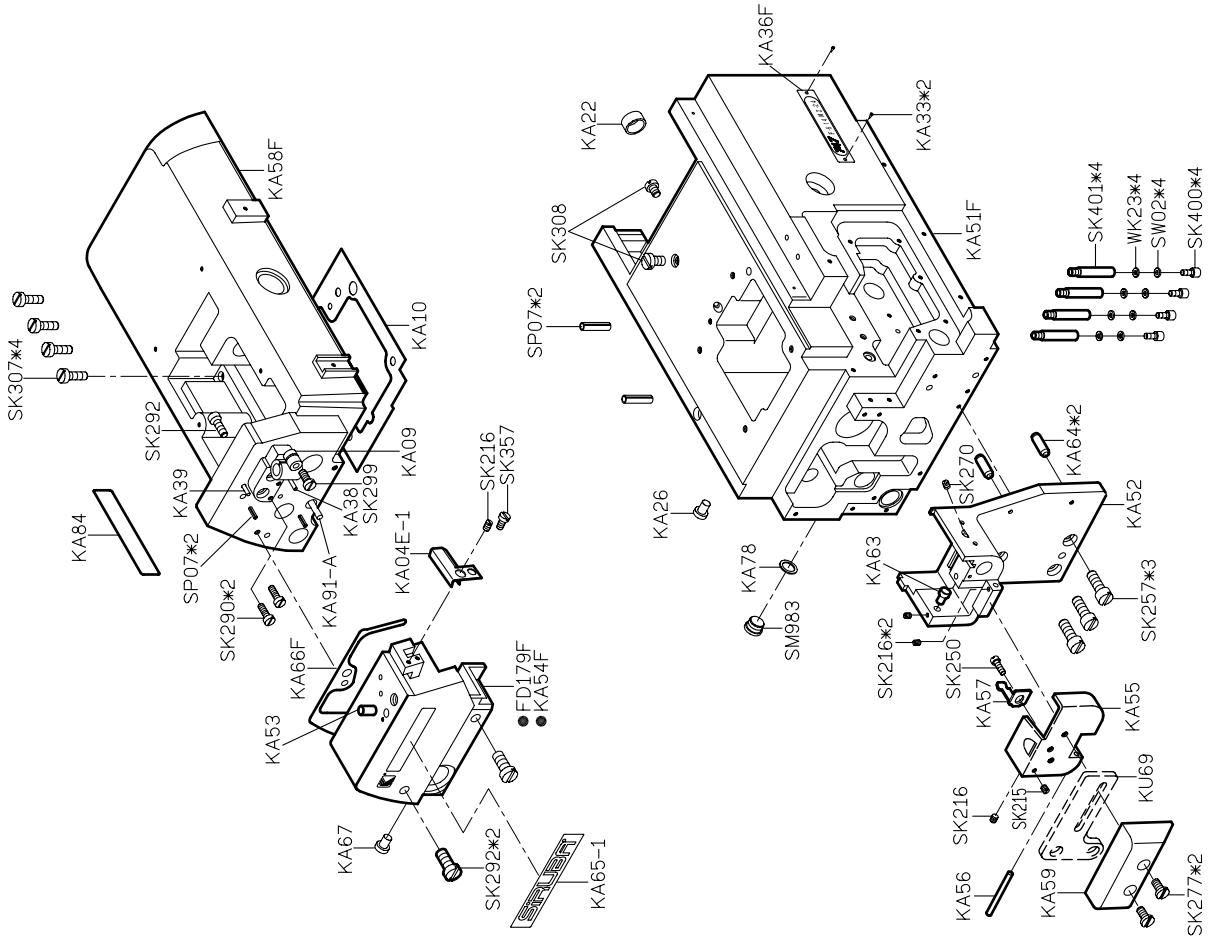



# PARTS LIST FOR KF GROUP

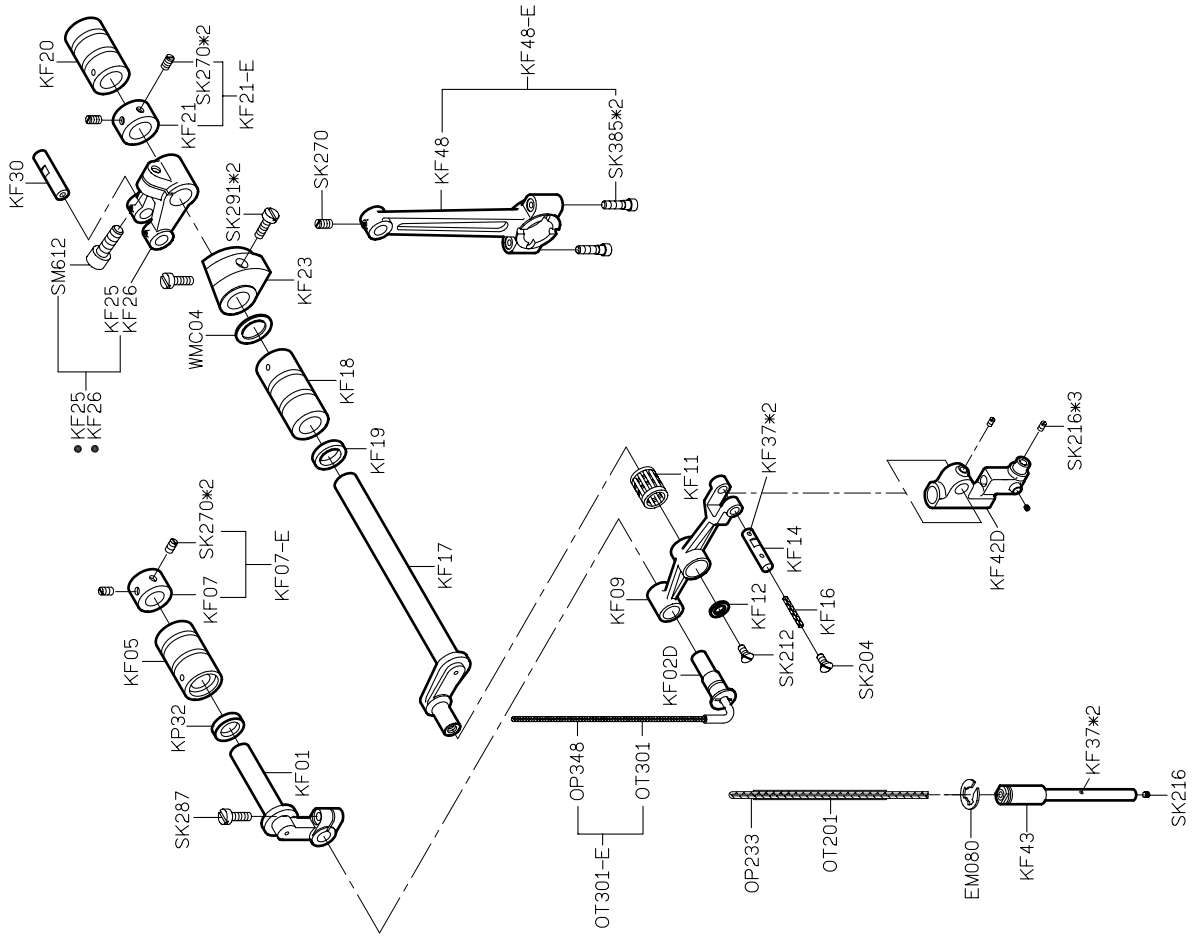

# PARTS LIST FOR KG GROUP

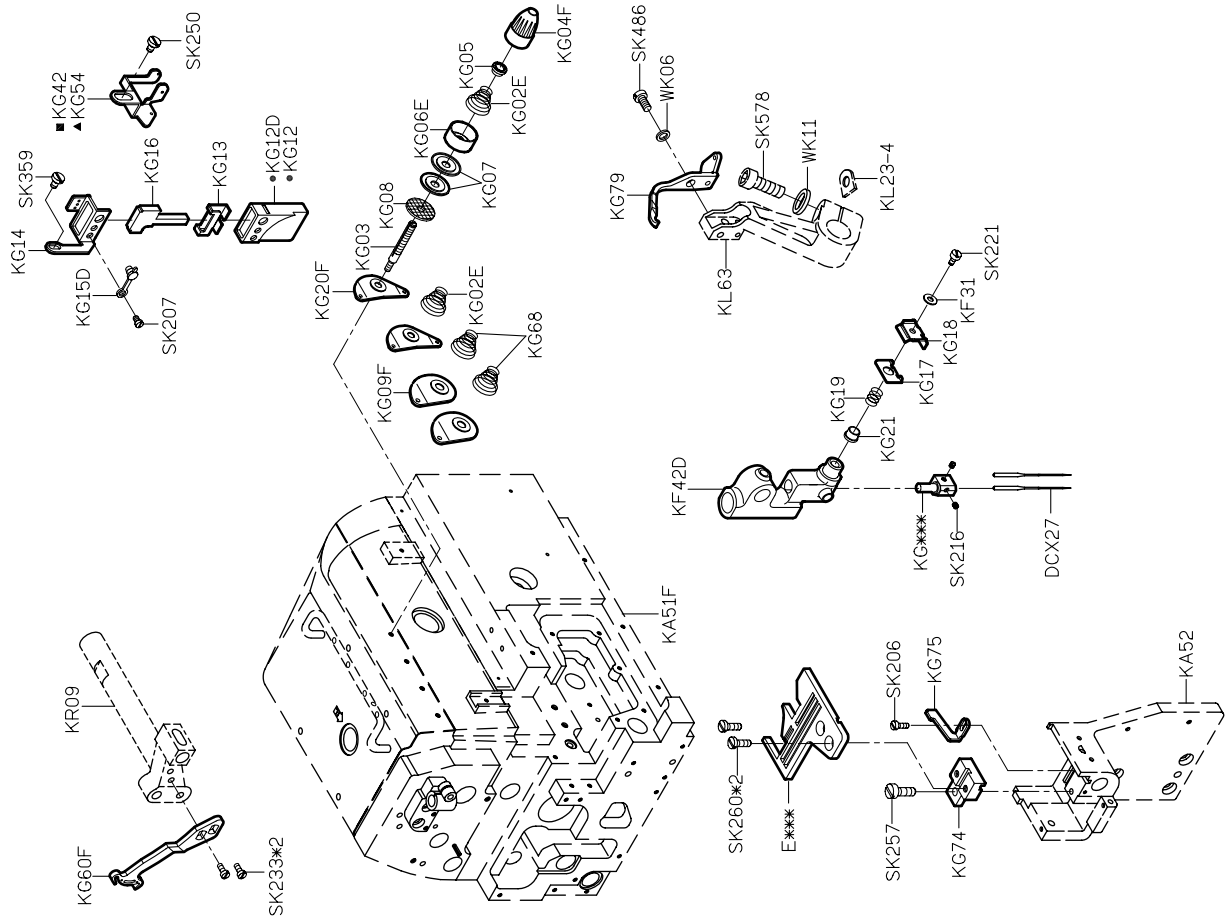

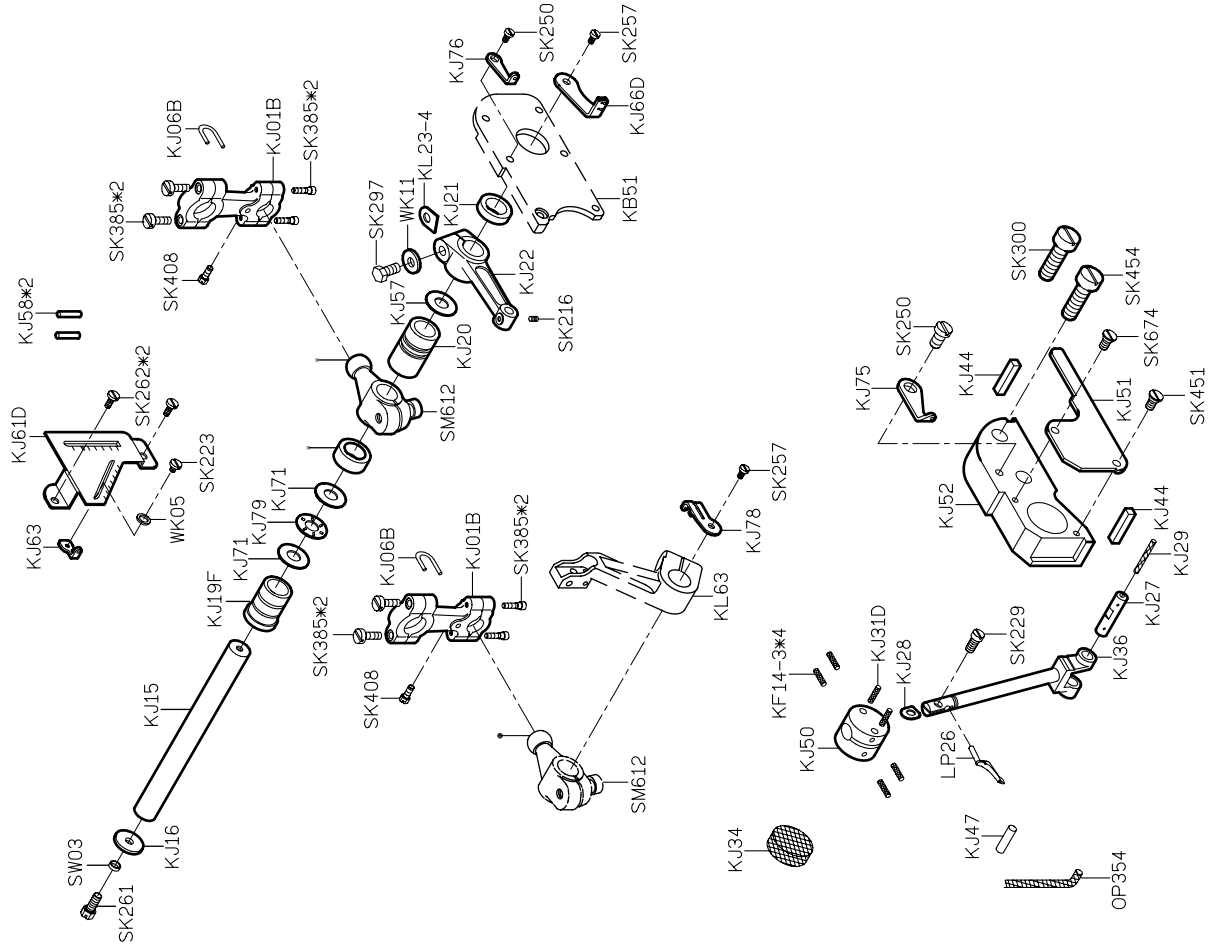
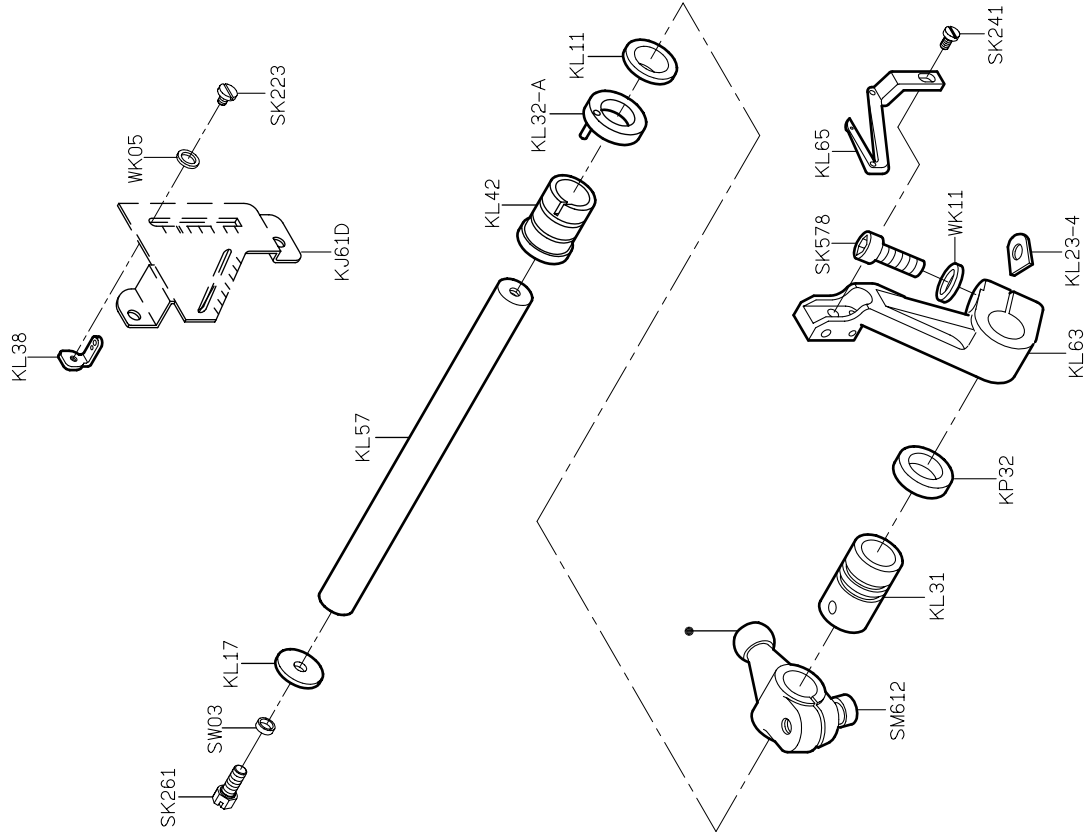

PARTS LIST FOR KJ GROUP

PARTS LIST FOR KL GROUP

PARTS LIST FOR KP GROUP

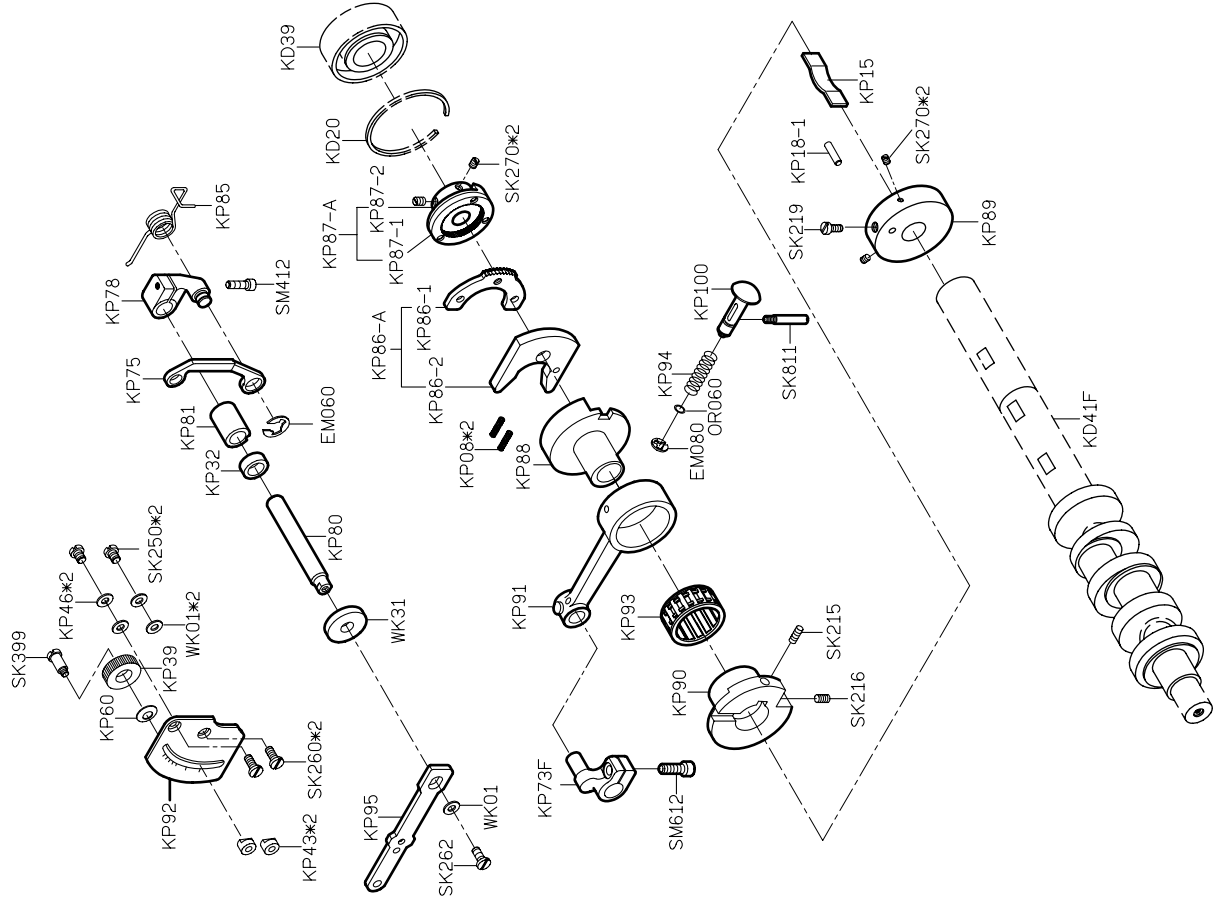

PARTS LIST FOR KQ GROUP

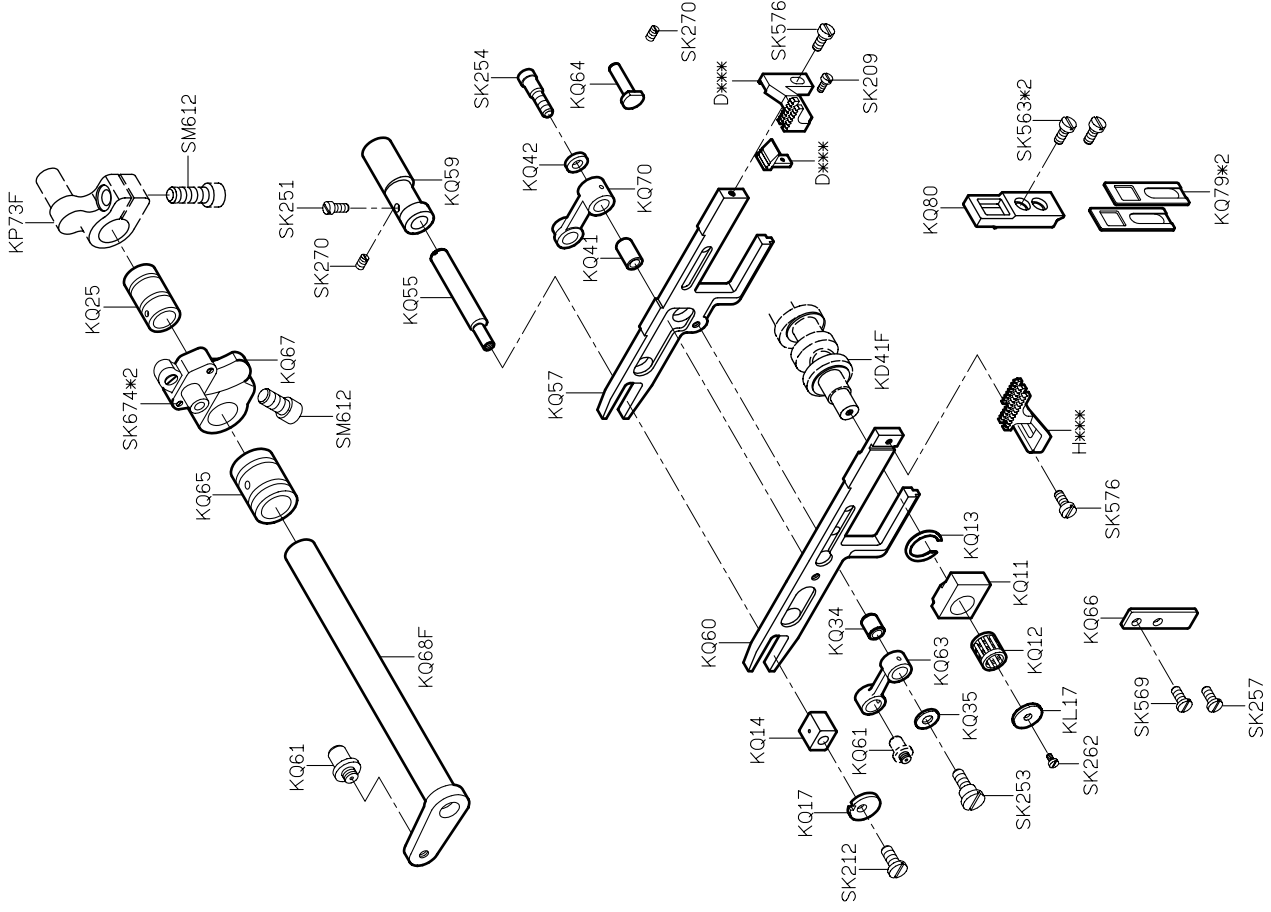





PARTS LIST FOR KU GROUP

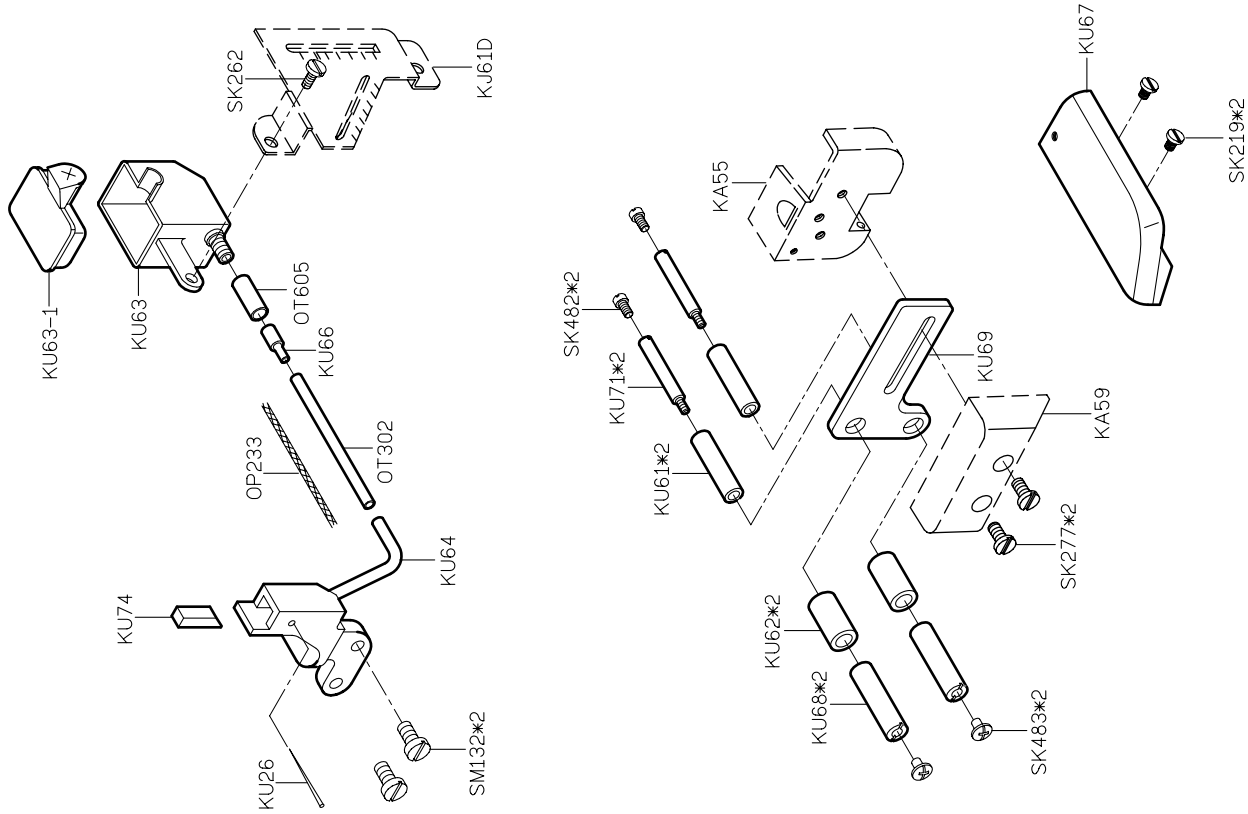

PARTS LIST FOR KT GROUP

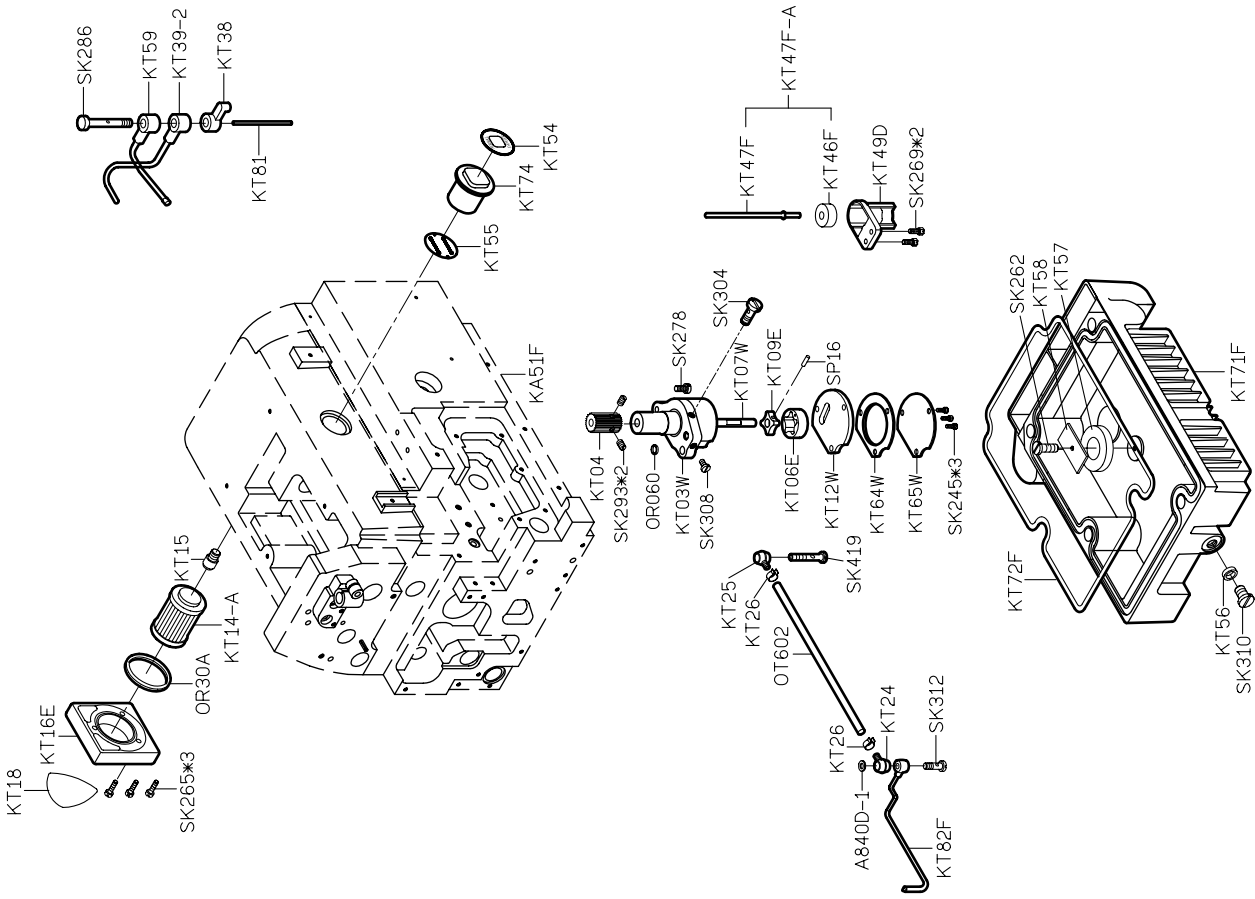

KW40E-3

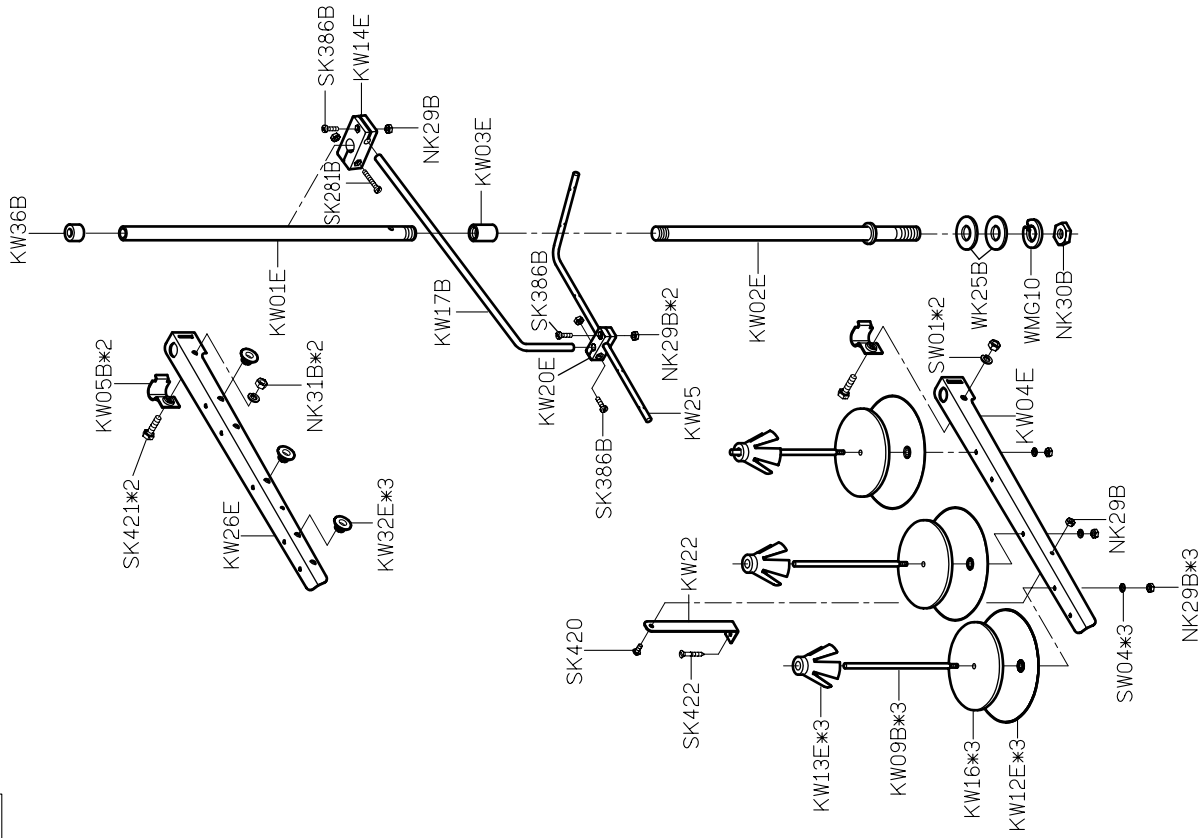

KW40E-4

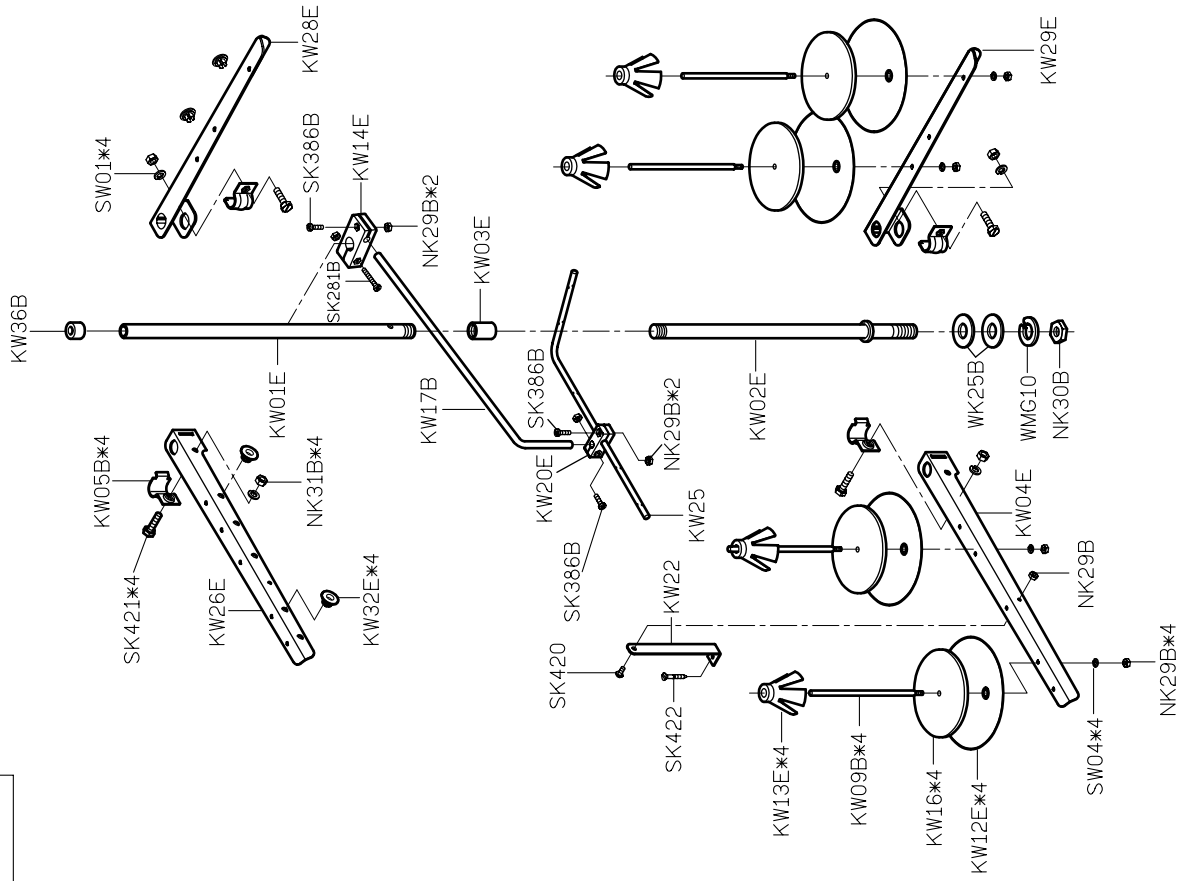

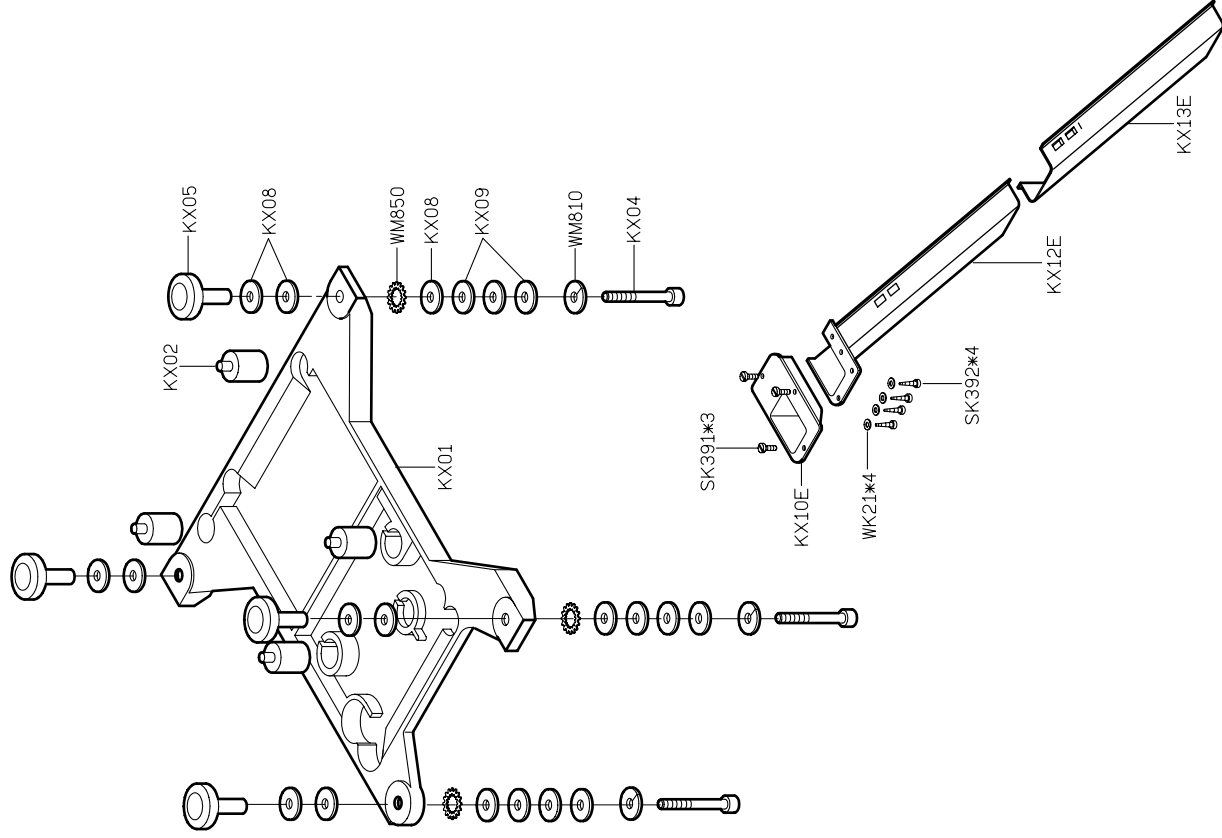

KY01 防塵罩 	KY02-A 油罐 	KY03 油壺 	KY04S 漏斗 	KY05 油壺 
KY07 開口板手 	KY08 開口板手 	KY09 開口板手 	KY10 六角板手 	KY11 六角板手 
KY12 六角板手 	KY14 內六角螺絲起子 	KY16 一字起子 	KY17 一字起子 	KY18 鑷子 
KY20D 腳踏板 	KY21-A/MY21 鉤子/鍊條 	KY26F 工具袋 	KR55 下刀片 	KT14-A 濾油器 
針*4 	SK216*2 螺絲 	MY11 六角板手 	KZ03 乾燥劑 	KZ13 使用說明書 

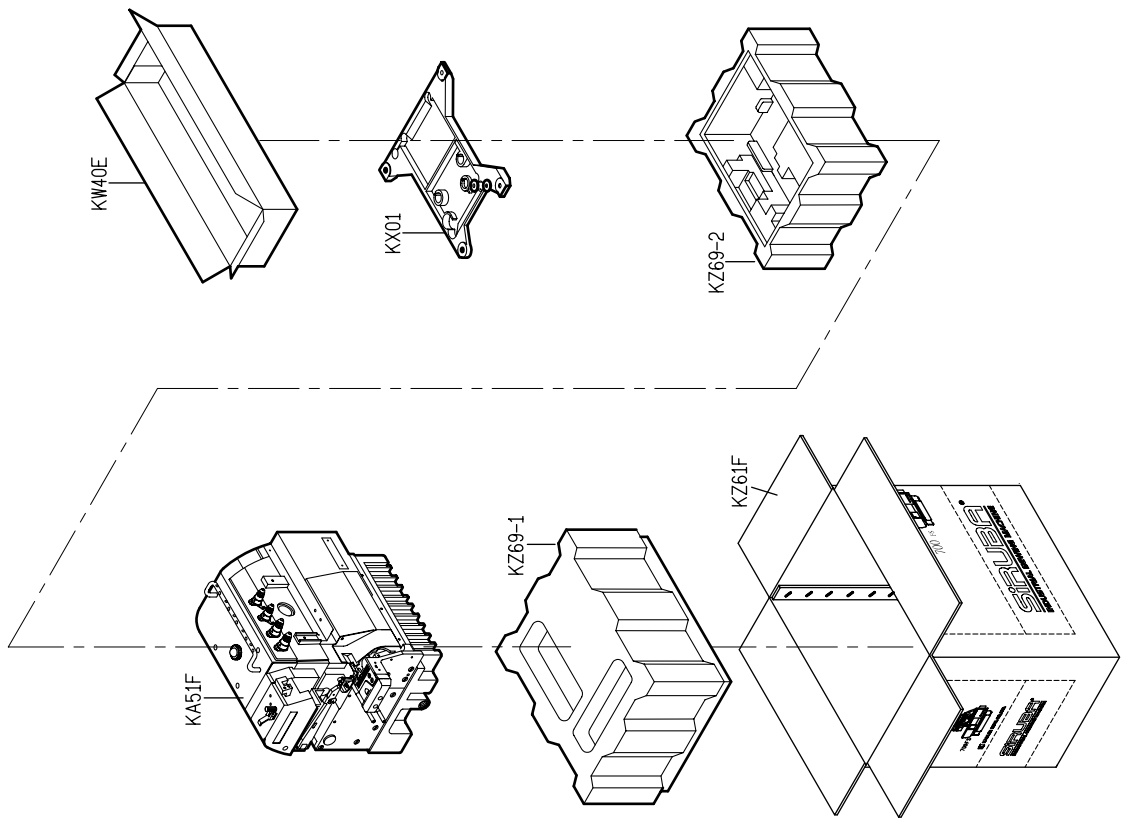



# 700FS

高林股份有限公司 KAULIN MFG. CO., LTD.